

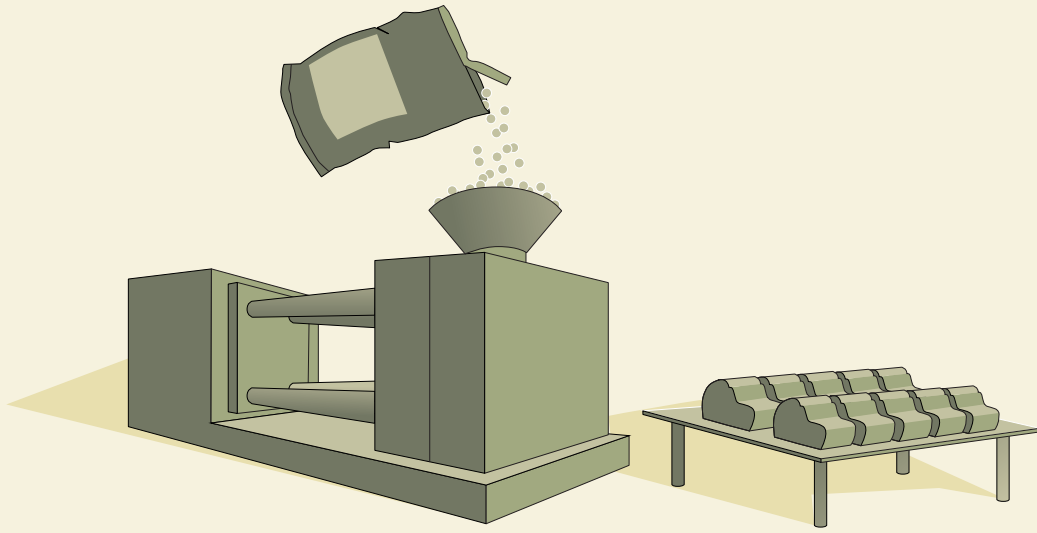

 PLASTIC INJECTION MOLDING

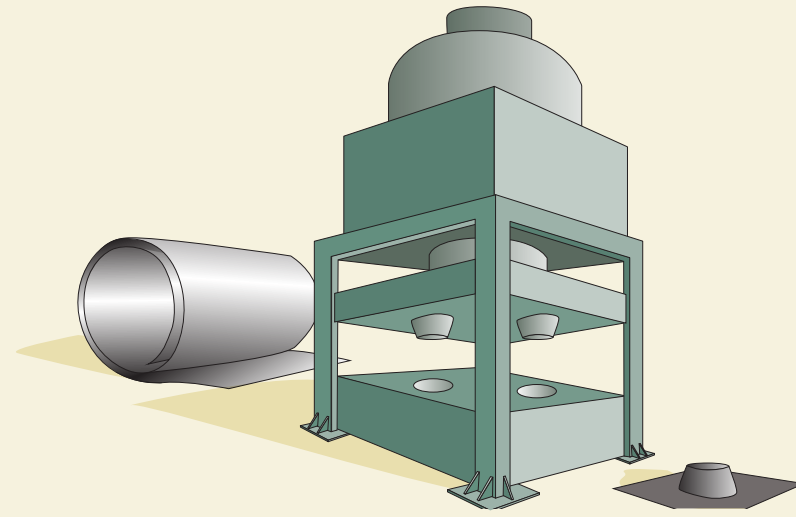

 STEEL STAMPING



 TUBE BENDING

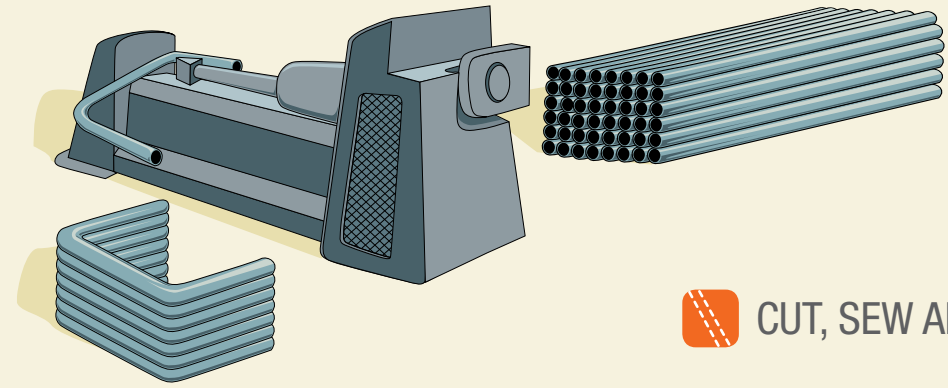

 CUT, SEW AND UPHOLSTERY

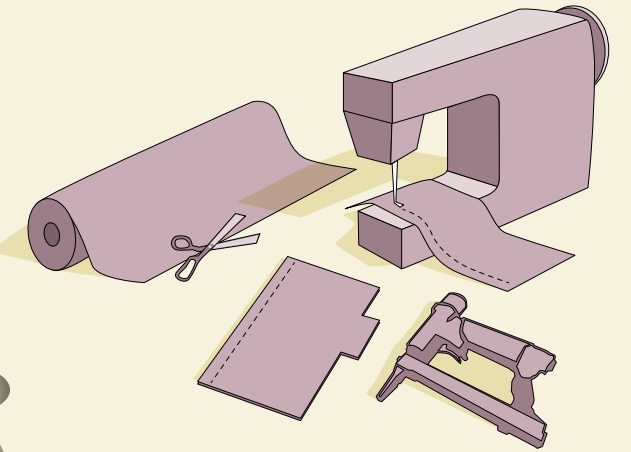

 ALUMINUM DIE-CASTING

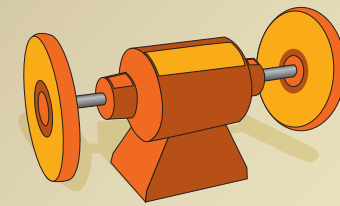
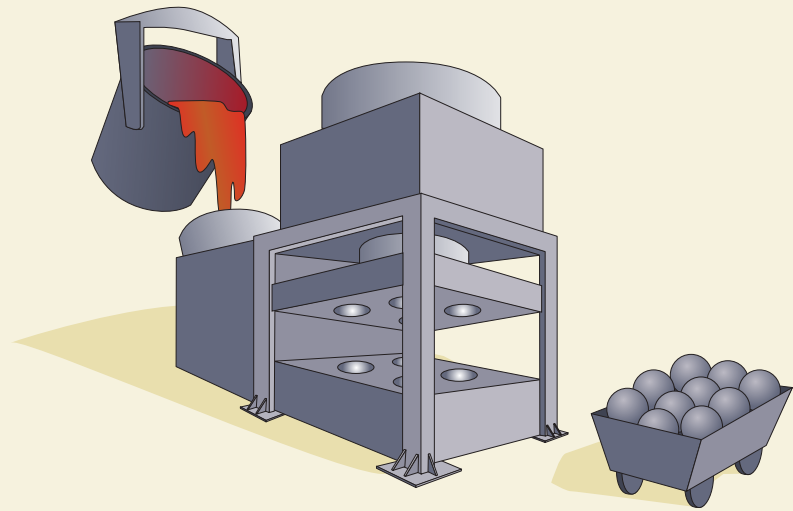

POLISHING

ROBOTIC WELDING

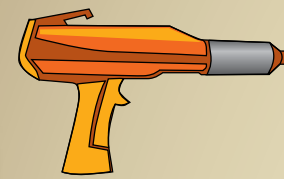
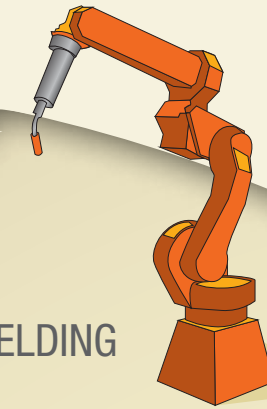

POWDER COATING

 PLYWOOD COMPRESSION MOLDING

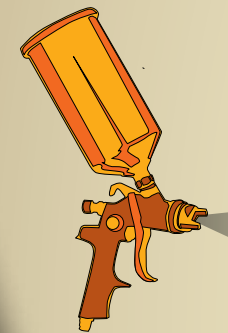
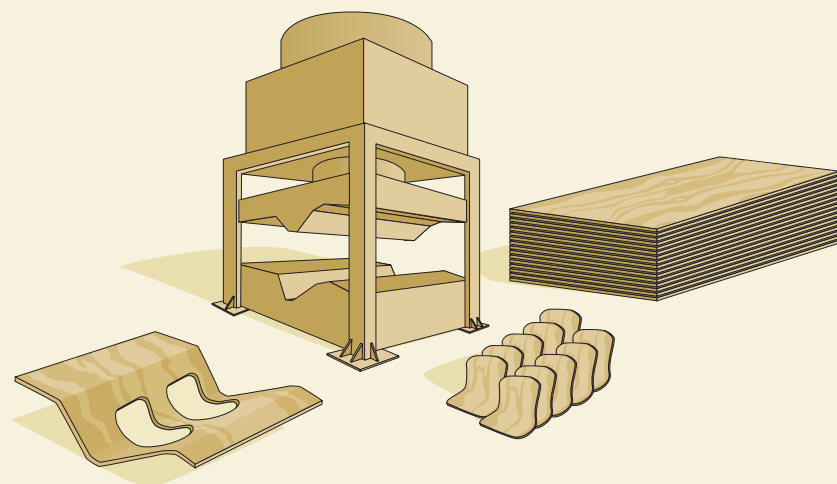

PLYWOOD FINISHING

FINAL ASSEMBLY

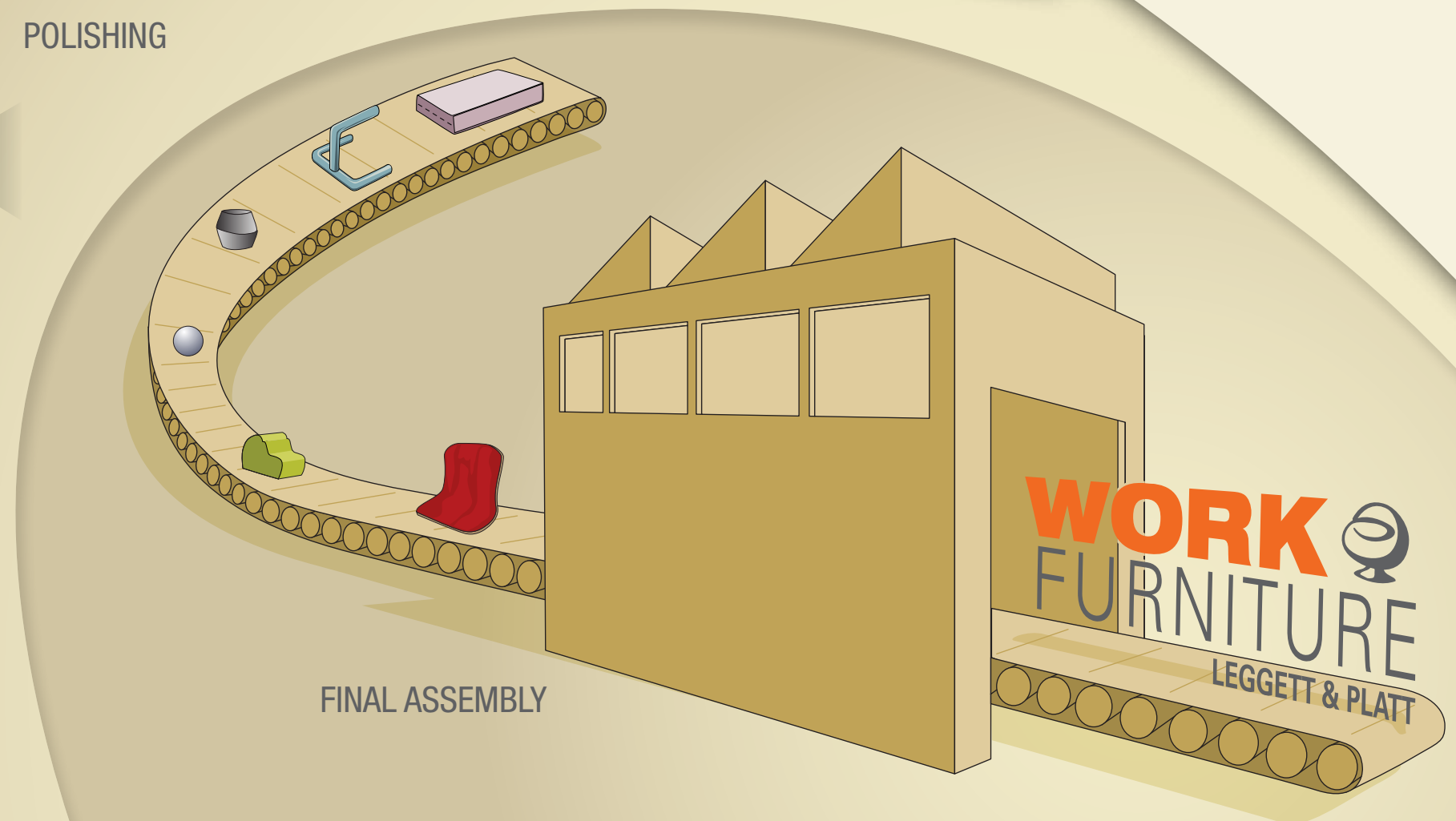

WORK
FURNITURE
LEGGETT & PLATT